



# Application Note: AN\_SY6970

## 5A, Single Cell Li-Ion DC/DC Switching Charger with I<sup>2</sup>C Control, USB Detection and OTG JEITA Compliant, Power Path Management

### Advanced Design Specification

### General Description

The SY6970 is a fully-integrated switching battery charger with system power path management devices for single cell Li-Ion and Li-polymer battery in a wide range of tablet and other portable devices. Its low impedance power path optimizes switching conversion efficiency, reduces battery charging time and extends battery life during the discharging mode. The I<sup>2</sup>C serial interface with charging and system settings makes the device a truly flexible solution.

The device supports a wide range of input sources, including standard USB host port, USB charging port and non-standard DC adapter. The SY6970 takes the result from the internal USB port identification circuit thru DP/DM compliant with BC1.2. The SY6970 can be compliant with USB 2.0 and USB 3.0 power spec with input current and voltage regulation. Meanwhile, the SY6970 meets USB On-the-go operation power rating specification by supplying 5V on BUS with current limit up to 2.4A.

The power path management regulates the system voltage slightly above battery voltage but does not drop below 3.5V minimum system voltage. With this feature, the switching converter will keep working to support the system load even when the battery is completely depleted or removed. When the input current limit or voltage limit is reached, the power path management will reduce the charging current to zero firstly. If the system load continues to increase, the power path will discharge the battery to provide the power required by system. This supplement mode operation prevents overloading the input source.

The device initiates and completes a charging cycle without software control. It automatically detects the battery voltage and charges the battery in three phases: preconditioning, constant current and

constant voltage. At the end of the charging cycle, the charger will automatically be terminated when the charge current is below a preset limit in the constant voltage phase. When the full battery falls below the recharge threshold, the charger will automatically start another charging cycle. The SY6970 can be compliant with JEITA spec for the Li-Ion battery.

The device provides various safety features for battery charging and system operation, including negative thermistor monitoring, charging safety timer and over-voltage/over-current protections. The thermal regulation reduces charge current when the junction temperature exceeds 120 °C(programmable).

The STAT output reports the charging status and any fault conditions. The INT immediately notifies the host when a fault occurs.

The SY6970 is available in QFN4x4-24 package.

### Ordering Information

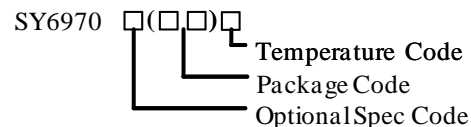

Ordering Number	Package type	Note
SY6970QCC	QFN4x4-24	

## Features

- High Efficiency 5A 1.5MHz Buck Mode Charger
  - Support 3.9V-14V Input Voltage Range
  - Programmable IDPM/VDPM to Support the USB and Adapter
  - Support USB SDP/DCP/CDP and Non-Standard Adapter Detection
  - 3.84-4.608V Adjustable Charge Voltage
  - Support Narrow VDC Power Path Management
  - JEITA Compliance
  - $\pm 0.5\%$  Charge Voltage Regulation
  - $\pm 7\%$  Charge Current Regulation
  - Accelerate Charge Time by Battery Path Impedance Compensation.
  - Charge Status Outputs for LED or Host Processor
- Maximum 2.4A 500KHz/1.5MHz Boost OTG Current
  - 4.55-5.51V Adjustable OTG Output Voltage
  - Selectable OTG Output Current Limit

- Up to 2.4A OTG Current Limit on BUS
- $\pm 1\%$  Output Regulation in Boost Mode
- Battery Monitor for Voltage, Temperature and Charge Current Measurements
- Full BATFET Control to Support Shipping Mode, Wake Up, and System Reset
- Up to 9A Battery Discharge Current
- Safety
  - Battery Temperature Sensing for Charge and Boost Mode
  - Battery Charging Safety Timer
  - Thermal Regulation and Thermal Shutdown
  - Input/System Over-voltage Protection
  - MOSFET Over-current Protection
- Low Battery Leakage Current and Support Shipping Mode
- 4mm x 4mm QFN-24 Package

## Applications

- Smart Phone
- Tablet PC
- Power Bank
- Portable Internet Devices

**Typical Applications**

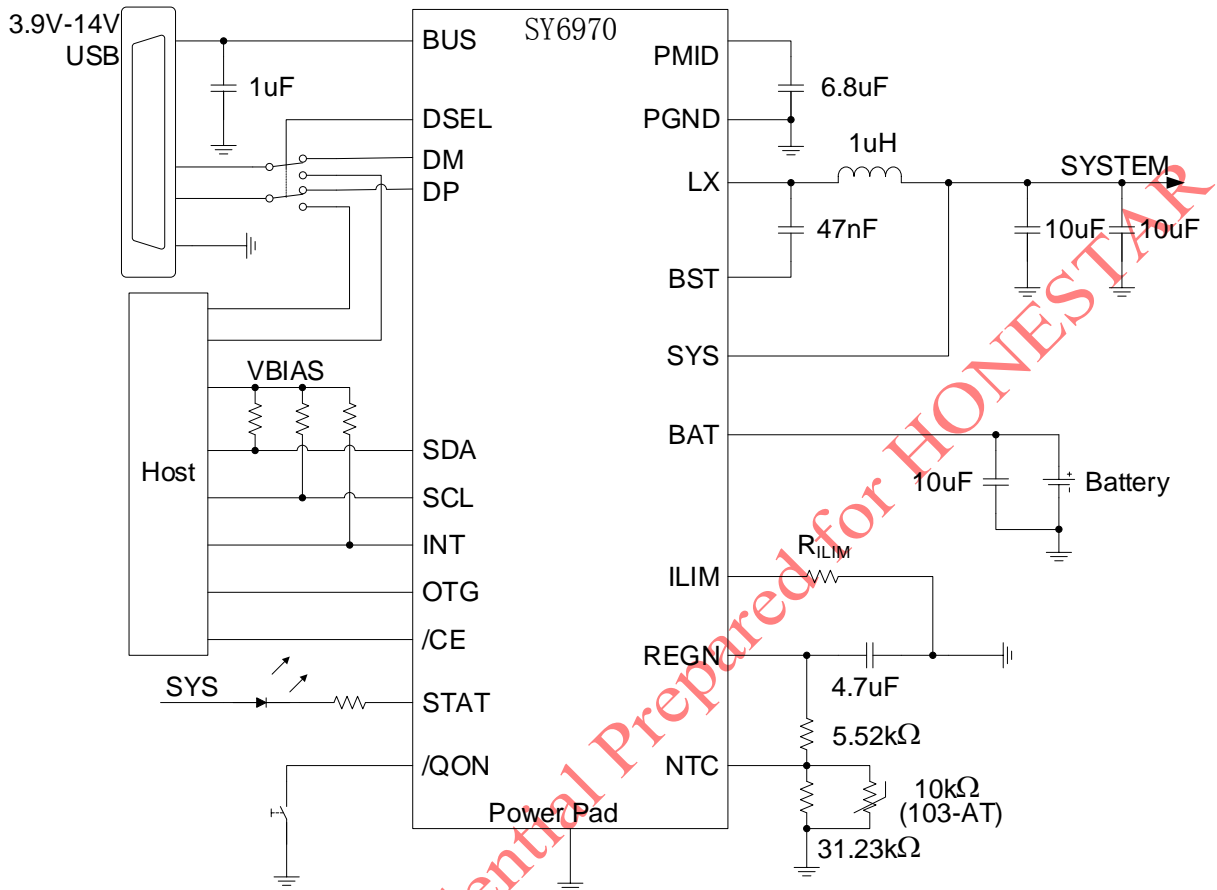

**Figure 1. Schematic Diagram**

## Pinout (top view)

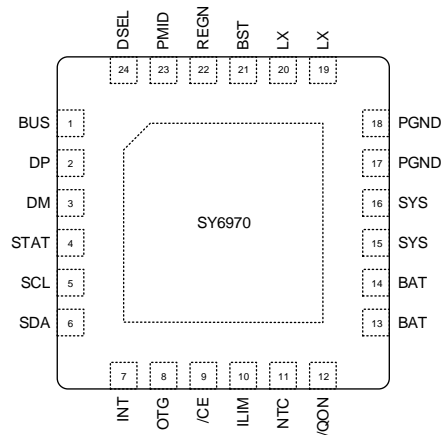

Top Mark: CDDxyz(device code: CDD, x=year code, y=week code, z=lot number code)

## Pin Description

Pin Name	Pin Number	Pin Description
BUS	1	Charger power input pin. Connect a 1 $\mu$ F ceramic capacitor from BUS to PGND as close as possible to the IC.
DP	2	USB identification port. USB detection strategy is compliant with BC1.2. SDP, CDP, DCP and adapter port can be identified according to the detection results thru DP/DM pins.
DM	3	
STAT	4	Open drain charge status indication pin. Pull up to a logic rail via 10k $\Omega$ resistor. STAT pin low indicates charge in progress; high indicates charge done or charge disabled. When any charge fault occurs, STAT pin blinks at 1Hz. The stat pin function can be disabled by setting STAT_DIS bit.
SCL	5	I <sup>2</sup> C Interface clock pin. Pull up to a logic rail via 10k $\Omega$ resistor.
SDA	6	I <sup>2</sup> C Interface data pin. Pull up to a logic rail via 10k $\Omega$ resistor.
INT	7	Open-drain Interrupt Output. Pull up to a logic rail via 10k $\Omega$ resistor. The INT pin generates active low, 256 $\mu$ s pulse to notify the host about charge status and charge fault.
OTG	8	Boost mode active high enable pin. Boost mode is enabled when REG03[5]=1 and OTG pin is high.
/CE	9	Charge mode active low enable pin. Battery charging is enabled when REG03[4]=1 and /CE pin =Low. /CE pin must be pulled high or low.
ILIM	10	ILIM pin sets the maximum input current limit. A resistor is connected from ILIM pin to ground to set the maximum limit as $I_{INMAX} = K_{ILIM} / R_{ILIM}$ . The actual input current limit is the lower one set by ILIM and by I <sup>2</sup> C REG00[5:0]. The ILIM pin function can be disabled by setting EN_ILIM bit to 0
NTC	11	Connect a resistor divider from REGN to NTC to GND to achieve battery

		<p>thermal protection. Charge or discharge suspends when NTC pin is out of range.</p> <p>Recommend 103AT-2 thermistor.</p>
/QON	12	<p>BATFET enables control in shipping mode and BATFET reset function.</p> <p>When BATFET is in shipping mode, logic high to low transition on this pin with minimum of <math>T_{QON\_L}</math> low level turns on BATFET to exit shipping mode. This pin is internally pulled up to maintain default high logic.</p> <p>When BUS is not plugged-in, a logic low of <math>T_{QON\_RST}</math>(typical 10s) resets system power by turning BATFET off for <math>T_{BATFET\_RST}</math>(typical 3s) and then re-enable BATFET.</p>
BAT	13,14	<p>Battery voltage sense pin. Used as battery constant voltage control and battery voltage protections. Connect at least 10uF ceramic capacitor to the BAT pin.</p>
SYS	15,16	<p>System connection point. The internal BATFET is connected between BAT and SYS. When the battery falls below the minimum system voltages, switch-mode converter will keep SYS above the minimum system voltage.</p>
PGND	17,18	<p>Power ground connection. On PCB layout, connect this pin directly to ground connection of input and output capacitors.</p>
LX	19,20	<p>Switching node pin. Connect this pin to external inductor.</p>
BST	21	<p>HSFET driver positive supply. Connect a 47nF bootstrap capacitor between LX and BST.</p>
REGN	22	<p>LSFET driver positive supply. Connect a 4.7μF ceramic capacitor between REGN and analog GND. The capacitor should be placed closely to the IC. REGN also serves as bias rail of NTC pin.</p>
PMID	23	<p>Connect this pin to the drain of the reverse blocking MOSFET and the drain of HSFET. Connect a 6.8μF capacitor between PMID and PGND. The capacitor should be placed closely to the IC.</p>
DSEL	24	<p>Open-drain DP/DM multiplexer selection control. Pull up to a logic rail via 10kΩ resistor. During input source type detection, the pin outputs low to indicate DP/DM detection is in progress. When detection is done, the pin keeps low if HVDCP is detected. The pin returns to float and pulls high by resistor when other input source type is detected.</p>
Exposed pad		<p>Exposed pad beneath the IC for heat dissipation. Always solder exposed pad to the board, and have vias on the power pad plane star-connecting to PGND and ground plane for high-current power converter.</p>

**Absolute Maximum Ratings** (Note 1)

BUS, PMID, LX	-----	-0.3V to +18V
Others	-----	-0.3V to +6V
Package Thermal Resistance (Notes 2)		
QFN4x4-24 $\theta_{JA}$	-----	33.3 °C/W
QFN4x4-24 $\theta_{JC}$	-----	29.7 °C/W
Junction Temperature Range	-----	-40 °C to +150 °C
Operating Temperature Range	-----	-40 °C to +100 °C
Storage Temperature	-----	-65 °C to +150 °C
Lead Temperature (Soldering, 10s)	-----	+300 °C
ESD Susceptibility		
HBM (Human Body Mode)	-----	2kV
MM (Machine Mode)	-----	200V

**Recommended Operating Conditions** (Note 3)

BUS, PMID, LX	-----	0V to +16V
Others	-----	0V to +5.5V
Junction Temperature Range	-----	-40 °C to 125 °C
Ambient Temperature Range	-----	-40 °C to 85 °C

Silergy Corp Confidential Prepared for HONESTAR

## Electrical Characteristics

( $V_{BUS\_UVLOZ} < V_{BUS} < V_{ACOV}$  and  $V_{BUS} > V_{BAT} + V_{SLEEP}$ ,  $T_A = 25\text{ }^\circ\text{C}$  for typical values unless other noted.)

Parameter	Symbol	Test Conditions	Min	Typ	Max	Unit
<b>QUIESCENT CURRENTS</b>						
Battery Discharge Current (BAT)	$I_{BAT}$	$V_{BUS} < V_{BUS\_UVLOZ}$ , $V_{BAT} = 4.2\text{ V}$ , leakage between BAT and BUS		5		$\mu\text{A}$
		High-Z Mode, no BUS, battery monitor disabled, BATFET disabled, $T_J < 85\text{ }^\circ\text{C}$		12		$\mu\text{A}$
		High-Z Mode, no BUS, battery monitor disabled, BATFT enabled, $T_J = -40\text{ }^\circ\text{C}$ to $85\text{ }^\circ\text{C}$		32		$\mu\text{A}$
Input Supply Current in High-Z Mode	$I_{BUS\_HIZ}$	$V_{BUS} = 5\text{ V}$ , battery monitor disabled, no battery, High-Z mode enabled		15		$\mu\text{A}$
		$V_{BUS} = 12\text{ V}$ , battery monitor disabled, no battery, High-Z mode enabled		25		$\mu\text{A}$
Input Supply Current (BUS)	$I_{BUS}$	$V_{BUS} > V_{BUS\_UVLOZ}$ , $V_{BUS} > V_{BAT}$ , converter not switching		1.5	3	$\text{mA}$
		$V_{BUS} > V_{BUS\_UVLOZ}$ , $V_{BUS} > V_{BAT}$ , converter switching, $V_{BAT} = 3.2\text{ V}$ , $I_{SYS} = 0\text{ A}$		3		$\text{mA}$
		$V_{BUS} > V_{BUS\_UVLOZ}$ , $V_{BUS} > V_{BAT}$ , converter switching, charge disabled, $V_{BAT} = 3.8\text{ V}$ , $I_{SYS} = 0\text{ A}$		3		$\text{mA}$
Battery Discharge Current in Boost Mode	$I_{OTGBOOST}$	$V_{BAT} = 4.2\text{ V}$ , Boost mode, $I_{BUS} = 0\text{ A}$ , converter switching		3.5		$\text{mA}$
<b>BUS/BAT POWER UP</b>						
BUS Operating Range	$V_{BUS\_OP}$		3.9		14	V
BUS for Active IC and I <sup>2</sup> C, No Battery	$V_{BUS\_UVLOZ}$	$V_{BUS}$ rising			3.6	V
Sleep Mode Falling Threshold	$V_{SLEEP}$	$V_{BUS}$ falling, $V_{BUS} - V_{BAT}$		65		mV
Sleep Mode Rising Threshold	$V_{SLEEPZ}$	$V_{BUS}$ rising, $V_{BUS} - V_{BAT}$		250		mV
BUS Over-voltage Rising Threshold	$V_{ACOV}$	$V_{BUS}$ rising		14.3		V
BUS Over-voltage Recovery Threshold	$V_{ACOV\_RC}$	$V_{BUS}$ falling		300		mV
Battery Depletion Threshold	$V_{BAT\_DPL}$	$V_{BAT}$ falling		2.3		V
Battery Depletion Recovery Threshold	$V_{BAT\_DPLZ}$	$V_{BAT}$ rising		2.5		V

POWER PATH MANAGEMENT						
System Regulation Voltage	V <sub>SYS_MAX</sub>	I <sub>SYS</sub> = 0A, V <sub>BAT</sub> > V <sub>SYSMIN</sub> , Q4 off, V <sub>BAT</sub> up to 4.35V, V <sub>SYS</sub> = V <sub>BAT</sub> + 50mV		4.4		V
System Voltage Output	V <sub>SYS_MIN</sub>	I <sub>SYS</sub> = 0A, V <sub>BAT</sub> < V <sub>SYSMIN</sub> = 3.5V, Q4 off, V <sub>SYS</sub> = V <sub>BAT</sub> + 150mV	3.5	3.65		V
Internal High-side Reverse Blocking MOSFET On-resistance	R <sub>ON(RBFET)</sub>	T <sub>J</sub> = -40 °C to 85 °C		25		mΩ
Internal High-side Switching MOSFET On-resistance Between PMID and LX	R <sub>ON(HSFET)</sub>	T <sub>J</sub> = -40 °C to 85 °C		25		mΩ
Internal Low-side Switching MOSFET On-resistance Between LX and PGND	R <sub>ON(LSFET)</sub>	T <sub>J</sub> = -40 °C to 85 °C		15		mΩ
BATTERY CHARGER						
Charge Voltage Regulation Accuracy	V <sub>BAT_REG_ACC</sub>	V <sub>BAT</sub> = 4.208V and 4.112V	-0.5%		0.5%	
Fast Charge Current Regulation Accuracy	I <sub>CHG_REG_ACC</sub>	V <sub>BAT</sub> = 3.8V, I <sub>CHG</sub> = 1792mA, T <sub>J</sub> = 25 °C	-5%		5%	
Battery LOWV Falling Threshold	V <sub>BATLOWV</sub>	Fast charge to precharge, BATLOWV bit=1 VBAT falling	2.6	2.8	2.9	V
Battery LOWV Rising Threshold	V <sub>BATLOWV_HYST</sub>	Precharge to fast charge, BATLOWV bit=1 VBAT rising		3.0		V
Termination Current Accuracy	I <sub>TERM_ACC</sub>	I <sub>TERM</sub> = 256mA, I <sub>CHG</sub> = 960mA	-20%		20%	
Battery Short Voltage	V <sub>SHORT</sub>	V <sub>BAT</sub> falling		2.0		V
Battery Short Voltage Hysteresis	V <sub>SHORT_HYST</sub>	V <sub>BAT</sub> rising		200		mV
Battery Short Current	I <sub>SHORT</sub>	V <sub>BAT</sub> < 2.2V		100		mA
Recharge Threshold Below V <sub>BAT_REG</sub>	V <sub>RECHG</sub>	V <sub>BAT</sub> falling, VRECHG bit=0		100		mV
Recharge Deglitch Time	t <sub>RECHG</sub>	V <sub>BAT</sub> falling, VRECHG bit=0		20		mS
SYS-BAT MOSFET On-resistance	R <sub>ON_BATFET</sub>			10		mΩ



<b>INPUT VOLTAGE/CURRENT REGULATION</b>						
Absolute Input Voltage Regulation Accuracy	$V_{INDPM\_REG\_A}$ CC		-2%		2%	
Input Current Limit Range	$I_{INDPM\_RANGE}$		100		3250	mA
USB Input Current Regulation Limit, BUS=5V, Current Drawn from LX	$I_{USB\_DPM}$	USB100		90	100	mA
		USB150		130	150	mA
		USB500		450	500	mA
		USB900		800	900	mA
Input Current Regulation Accuracy	$I_{ADPT\_DPM}$	I <sup>2</sup> C Set input current limit above 900mA	-20%		0%	
$I_{IN} = K_{ILIM}/R_{ILIM}$	$K_{ILIM}$	$I_{INDPM} = 1.5A$		360		AΩ
<b>DP/DM DETECTION</b>						
DP/DM Voltage source	$V_{DP\_SRC}$ $V_{DM\_SRC}$		0.5	0.6	0.7	V
Data Detect Voltage	$V_{DAT\_REF}$		250		400	mV
<b>BAT OVER-VOLTAGE PROTECTION</b>						
Battery Over-voltage Threshold	$V_{BATOVP}$	$V_{BAT}$ rising, as percentage of $V_{BAT\_REG}$		104%		
Battery Over-voltage Hysteresis	$V_{BATOVP\_HYST}$	$V_{BAT}$ falling, as percentage of $V_{BAT\_REG}$		2%		
<b>BAT DISCHARGE OVER-CURRENT PROTECTION</b>						
BATFET Discharge Over-current Threshold	$I_{BATFET\_OCP}$		9			A
<b>THERMAL REGULATION AND THERMAL SHUTDOWN</b>						
Junction Temperature Regulation Accuracy	$T_{JUNCTION\_REG}$	TREG bits=11		120		°C
Thermal Shutdown Rising Temperature	$T_{TSD}$	Temperature increasing		160		°C
Thermal Shutdown Hysteresis	$T_{TSD\_HYS}$			30		°C
<b>JEITA THERMISTER Comparator</b>						
T1(0°C) threshold, charge suspended below this temp	$V_{T1}$	$V_{NTC}$ rising, as percentage to $V_{REGN}$ , JEITA_ISET=0		73.25		%
Charge back to $I_{CHG}/2$ and $V_{REG}$ above this temp	$V_{T1\_HYS}$	Hysteresis, $V_{NTC}$ falling, JEITA_ISET=0		1.25		%
T2(10°C) threshold, Charge Back to $I_{CHG}/2$ and $V_{REG}$ below this Temp	$V_{T2}$	$V_{NTC}$ rising, as percentage to $V_{REGN}$ , JEITA_ISET=0		68.25		%
Charge back to $I_{CHG}$ and $V_{REG}$ above this temp	$V_{T2\_HYS}$	Hysteresis, $V_{NTC}$ falling, JEITA_ISET=0		1.25		%

T3(45°C) threshold, Charge back to I <sub>CHG</sub> and V <sub>REG</sub> -150mV above This temp	V <sub>T3</sub>	V <sub>NTC</sub> falling, as percentage to V <sub>REGN</sub> , JEITA_VSET=0		44.75		%
Charge back to I <sub>CHG</sub> and V <sub>REG</sub> below this temp	V <sub>T3_HYS</sub>	Hysteresis, V <sub>NTC</sub> rising, JEITA_VSET=0		1.2		%
T5(60°C) threshold, charge suspended above this temp	V <sub>T5</sub>	V <sub>NTC</sub> falling, as percentage to V <sub>REGN</sub> , JEITA_VSET=0		34.375		%
Charge back to I <sub>CHG</sub> and V <sub>REG</sub> -150mV below this temp	V <sub>T5_HYS</sub>	Hysteresis, V <sub>NTC</sub> rising, JEITA_VSET=0		1.2		%
<b>BOOST MODE THERMISTOR COMPARATOR</b>						
Cold Temperature Threshold 0, NTC Pin Voltage Rising Threshold	V <sub>BCOLD0</sub>	As Percentage to V <sub>REGN</sub> (Approx. -10°C w/ 103AT)		77		%
Falling Hysteresis	V <sub>BCOLD0_HYS</sub>	(Approx. 1°C w/ 103AT)		1.25		%
Cold Temperature Threshold 1, NTC Pin Voltage Rising Threshold	V <sub>BCOLD1</sub>	As Percentage to V <sub>REGN</sub> (Approx. -20°C w/ 103AT)		80		%
Falling Hysteresis	V <sub>BCOLD1_HYS</sub>	(Approx. 1°C w/ 103AT)		1.25		%
Hot Temperature Threshold 0, NTC pin Voltage Falling Threshold	V <sub>BHOT0</sub>	As Percentage to V <sub>REGN</sub> (Approx. 55°C w/ 103AT)		37.75		%
Rising Hysteresis	V <sub>BHOT0_HYS</sub>	(Approx. 3°C w/ 103AT)		1.2		%
Hot Temperature Threshold 1, NTC pin Voltage Falling Threshold	V <sub>BHOT1</sub>	As Percentage to V <sub>REGN</sub> (Approx. 60°C w/ 103AT)		34.37		%
Rising Hysteresis	V <sub>BHOT1_HYS</sub>	(Approx. 3°C w/ 103AT)		1.2		%
Hot Temperature Threshold 2, NTC Pin Voltage Falling Threshold	V <sub>BHOT2</sub>	As Percentage to V <sub>REGN</sub> (Approx. 65°C w/ 103AT)		31.25		%
Rising Hysteresis	V <sub>BHOT2_HYS</sub>	(Approx. 3°C w/ 103AT)		1.2		%
<b>BUCK MODE OPERATIONS</b>						
HSFET Cycle-by-cycle current limit	I <sub>HSFET_OCP</sub>			8		A
PWM Switching Frequency	F <sub>SW</sub>			1500		kHz
<b>BOOST MODE OPERATIONS</b>						
PWM Switching Frequency	F <sub>SW_BOOST1</sub>	V <sub>BAT</sub> =3.2V, V <sub>BUS</sub> =5V, I <sub>BUS</sub> =1A, BOOST_FREQ=1.5M		1500		kHz
PWM Switching Frequency	F <sub>SW_BOOST2</sub>	V <sub>BAT</sub> =3.2V, V <sub>BUS</sub> =5V, I <sub>BUS</sub> =1A, BOOST_FREQ=0.5M		500		kHz
OTG output Voltage	V <sub>OTG_REG</sub>	I <sub>BUS</sub> =0	4.5		5.5	V
OTG output Voltage Accuracy	V <sub>OTG_REG_ACC</sub>	I <sub>BUS</sub> =0	-2%		2%	
Battery Voltage Exiting Boost Mode	V <sub>OTG_BAT</sub>	BAT falling		2.8		V

OTG Mode Output Current Limit	I <sub>OTG_OCP</sub>	BOOST_LIM≥1.2A	+100%	+115%		
OTG Over-voltage Threshold	V <sub>OTG_OVP</sub>			6		V
OTG Over-voltage Threshold Hysteresis	V <sub>OTG_OVP</sub>			300		mV
LSFET Cycle-by-cycle Current Limit	V <sub>OTG_ILIM</sub>			7		A
<b>REGN LDO</b>						
REGN LDO Output Voltage	V <sub>REGN</sub>	V <sub>BUS</sub> = 5V, I <sub>REGN</sub> = 20mA		4.8		V
REGN LDO Current Limit	I <sub>REGN</sub>	V <sub>BUS</sub> = 5V, V <sub>REGN</sub> = 3.8V	50			mA
<b>BATTERY MONITOR</b>						
Resolution	RES			7		bits
<b>/QON TIMING</b>						
/QON Low Time to Turn on BATFET and Exit Ship Mode	T <sub>QON_LOW</sub>		1.25		2.25	s
/QON Low Time to Reset BATFET	T <sub>QON_RST</sub>		12		18	s
Reset Duration(BATFET Off time)	T <sub>BATFET_RST</sub>		0.35		0.55	s
t <sub>SM_DLY</sub>	Enter ship mode delay		10		15	s
<b>LOGIC I/O PIN CHARACTERISTICS (OTG, /CE, STAT, /QON, DSEL)</b>						
Input Low Threshold	V <sub>LOW</sub>				0.4	V
Input High Threshold	V <sub>IHIGH</sub>		1.3			V
Output Low Saturation voltage	V <sub>OUT_LOW</sub>	Sink current = 5 mA			0.4	V
<b>I<sup>2</sup>C INTERFACE (SDA, SCL, INT)</b>						
Input High Threshold Level	V <sub>IH</sub>	V <sub>PULL-UP</sub> = 1.8V, SDA and SCL	1.3			V
Input Low Threshold Level	V <sub>IL</sub>	V <sub>PULL-UP</sub> = 1.8V, SDA and SCL			0.4	V
Output Low Threshold Level	V <sub>OL</sub>	Sink current = 5mA			0.4	V
SCL Clock Frequency	f <sub>SCL</sub>				400	kHz
<b>DIGITAL CLOCK AND WATCHDOG TIMER</b>						
WATCHDOG=H1	t <sub>WDT</sub>		100	160		s

**Note 1:** Stresses beyond the “Absolute Maximum Ratings” may cause permanent damage to the device. These are stress ratings only. Functional operation of the device at these or any other conditions beyond those indicated in the operational sections of the specification is not implied. Exposure to absolute maximum rating conditions for extended periods may affect device reliability.

**Note 2:**  $\theta_{JA}$  is measured in the natural convection at  $T_A = 25\text{ }^\circ\text{C}$  on a low effective four layer thermal conductivity test board of JEDEC 51-3 thermal measurement standard.

**Note 3:** The device is not guaranteed to function outside its operating conditions.

## I<sup>2</sup>C Registers

Address: 6AH

### REG00

BIT	Name	POR	DESCRIPTION
7	EN_HIZ	0	<b>Enable HIZ Mode:</b> 0–Disable, 1–Enable
6	EN_ILIM	1	<b>Enable ILIM Pin:</b> 0–Disable, 1–Enable
5:0	IINLIM[5:0]	001000	<b>Input current limit:</b> (Actual input current limit is the lower of I <sup>2</sup> C or ILIM pin) IINLIM=100mA+50mA*[IINLIM] Range:100ma(000000)-3.25A(111111) 000000=100mA 000001=150mA ... 001000=500mA(Default) ... 111111=3.25A IINLIM will be changed according to the adapter type after input DP/DM detection is done. USB Host SDP=500mA with OTG=High USB Host SDP=100mA with OTG=Low USB CDP=1.5A USB DCP=3.25A

### REG01

BIT	Name	POR	DESCRIPTION
7:6	BHOT[1:0]	00	<b>BOOST mode Hot Temperature Monitor Threshold:</b> 00-VBHOT0 Threshold (Typ. 37.75%) 01-VBHOT1 Threshold (Typ. 34.37%) 10/11-VBHOT2 Threshold (Typ. 31.25%)
5	BCOLD	0	<b>BOOST mode Cold Temperature Monitor Threshold:</b> 0-VBCOLD0 Threshold (Typ. 77%) 1-VBCOLD1 Threshold (Typ. 80%)

4:0	VINDPM_OS[4:0]	00110	<b>Input Voltage Limit Offset:</b> VINDPM_OS=100mV*[VINDPM_OS] Range:0mV-3100mV 00000=0mV 00001=100mV ... 00110=600mV(Default) ... 11111=3100mV Final minimum VINDPM threshold is clamped at 3.9V When V <sub>BUS</sub> @no load is ≤6V The VINDPM_OS is used for calculating VINDPM value. When V <sub>BUS</sub> @no load is > 6V The VINDPM_OS*2 is used for calculating VINDPM value.
-----	----------------	-------	---

**REG02**

BIT	Name	POR	DESCRIPTION
7	CONV_START	0	<b>ADC Conversion Start Control:</b> 0-ADC not active 1-Start ADC Conversion This bit is read-only when CONV_RATE=1. The bit stays high during ADC conversion or pending ADC conversion during input source detection.
6	CONV_RATE	0	<b>ADC Conversion Rate Selection:</b> 0-One Short ADC Conversion 1-Start 1s continuous Conversion When CONV_RATE=0, CONV_START requires to be set to start conversion. When CONV_RATE=1, ADC conversion starts automatically and CONV_START is set during conversion.
5	BOOST_FREQ	0	<b>Boost Mode Frequency Selection:</b> 0-1.5MHZ 1-500KHZ Write to this bit is ignored when OTG_CONFIG is enabled.
4	AICL_EN	1	<b>Adaptive Input Current Limit Enable:</b> 0-Disable 1-Enable
3	HVDCP_EN	1	<b>HVDCP Enable:</b> 0-Disable HVDCP handshake 1-Enable HVDCP handshake
2	HV_TYPE	1	<b>Higher Voltage Types can be Requested:</b> 0-9V 1-12V

1	FORCE_DPDM	0	<b>Force DP/DM detection:</b> 0-Not in DP/DM detection 1-Force DP/DM detection
0	AUTO_DPDM_EN	1	<b>Automatic DP/DM detection Enable:</b> 0-Disable DPDM detection when BUS is plugged-in. 1-Enable DPDM detection when BUS is plugged-in.

**REG03**

BIT	Name	POR	DESCRIPTION
7	BAT_LOAD_EN	0	<b>Battery Load (10mA) Enable:</b> 0-Disable 1-Enable
6	WD_RST	0	<b>I<sup>2</sup>C Watchdog Timer Reset:</b> 0-Normal 1-Reset Back to 0 after timer reset.
5	OTG_CONFIG	0	<b>Boost (OTG) Mode Configuration:</b> 0-OTG Disable 1-OTG Enable
4	CHG_CONFIG	1	<b>Charge Enable Configuration:</b> 0-Charge Disable 1-Charge Enable
3:1	SYS_MIN[2:0]	101	<b>Minimum System Voltage Limit:</b> SYS_MIN=3.0V+[SYS_MIN]*0.1V Range:3.0V-3.7V 000=3.0V 001=3.1V ... 101=3.5V(Default) ... 111=3.7V
0	Reserved	0	Reserved

**REG04**

BIT	Name	POR	DESCRIPTION
7	EN_PUMPX	0	
6:0	ICHG[6:0]	01000 00	<b>Fast Charge Current Limit:</b> ICHG=[ICHG]*64mA Range:0mA(0000000)-5056mA(1001111) 0000000=0mA(Disable Charge) 0000001=64mA ... 0100000=2048mA(Default) ... 1001111~1111111=5056mA

**REG05**

BIT	Name	POR	DESCRIPTION
7:4	IPRECHG [3:0]	0001	<b>Precharge Current Limit:</b> IPRECHG=64mA+[IPRECHG]*64mA Range:64mA-1024mA 0000=64mA 0001=128mA(Default) ... 1111=1024mA
3:0	ITERM [3:0]	0011	<b>Termination Current Limit:</b> ITERM=64mA+[ITERM]*64mA Range:64mA-1024mA 0000=64mA 0001=128mA ... 0011=256mA(Default) ... 1111=1024mA

**REG06**

BIT	Name	POR	DESCRIPTION
7:2	VREG[5:0]	01011 1	<b>Charge Voltage Limit:</b> VREG=3.840V+[VREG]*16mV Range:3.840V-4.608V(110000) 000000=3.840V 000001=3.856V ... 010111=4.208V(Default) ... 110000~111111=4.608V
1	BATLOWV	1	<b>Battery Precharge to Fast Charge Threshold:</b> 0-2.8V 1-3.0V
0	VRECHG	0	<b>Battery Recharge Threshold Offset:</b> 0-100mV 1-200mV

**REG07**

BIT	Name	POR	DESCRIPTION
7	EN_TERM	1	<b>Charging Termination Enable:</b> 0-Disable 1-Enable
6	STAT_DIS	0	<b>STAT<sub>pin</sub> Disable:</b> 0-Enable 1-Disable
5:4	WATCHDOG[1:0]	01	<b>TC Watchdog Timer Setting:</b> 00-Disable timer 01-40s 10-80s 11-160s
3	EN_TIMER	1	<b>Charging Safety Timer Enable:</b> 0-Disable 1-Enable
2:1	CHG_TIMER[1:0]	10	<b>Fast Charge Timer Setting:</b> 00-5 hrs 01-8 hrs 10-12 hrs 11-20 hrs
0	JEITA_ISET (0°C-10°C)	1	<b>JEITA Low Temperature Current Setting</b> Percentage with respect to ICHG register REG04[6:0] 0-50% 1-20%



**REG08**

BIT	Name	POR	DESCRIPTION
7:5	BAT_COMP[2:0]	000	<b>IR Compensation Resistor Setting:</b> BAT_COMP=[BAT_COMP]*20mohm Range:0-140mohm 000=0mohm(Default) 001=20mohm ... 111=140mohm
4:2	VCLAMP[2:0]	000	<b>IR Compensation Voltage Clamp:</b> VCLAMP= [VCLAMP]*32mV. The regulation voltage is clamped at VREG+VCLAMP. Range:0-224mV 000=0(Default) 001=32mV ... 111=224mV
1:0	TREG[1:0]	11	<b>Thermal Regulation Threshold:</b> 00-60 °C 01-80 °C 10-100 °C 11-120 °C (Default)

**REG09**

BIT	Name	POR	DESCRIPTION
7	FORCE_AICL	0	<b>Force Start Adaptive Input Current Limit:</b> 0-Do not force 1-Force
6	TMR2X_EN	1	<b>Safety Timer Setting during Input DPM and Thermal Regulation:</b> 0-Safety timer not slowed by 2X during input DPM or thermal regulation. 1-Safety timer slowed by 2X during input DPM or thermal regulation.
5	BATFET_DIS	0	<b>Force BATFET Off:</b> 0-Allow Q4 turn on 1-Turn off Q4
4	JEITA_VSET (45°C-60°C)	0	<b>JEITA High Temperature Voltage Setting:</b> 0-VREG-150mV, 1-VREG
3	BATFET_DLY	0	<b>BATFET turn off delay control:</b> 0-Turn off BATFET immediately when BATFET_DIS is set. 1-Turn off BATFET with the delay $t_{SM\_DLY}$ when BATFET_DIS is set.



2	BATFET_RST_EN	1	<b>BATFET Reset Enable:</b> 0-Disable BATFET reset function 1-Enable BATFET reset function
1	PUMPX_UP	0	<b>Current pulse control to request higher voltage:</b> 0-Disable 1-Enable
1	PUMPX_DN	0	<b>Current pulse control to request lower voltage:</b> 0-Disable 1-Enable

REG0A

BIT	Name	POR	DESCRIPTION
7:4	BOOSTV[3:0]	0111	<b>Boost Mode Voltage Regulation:</b> VBOOST=4.55V+[BOOSTV]*64mV Range:4.55V-5.51V 0000=4.55V 0001=4.614V ... 0111=4.998V(Default) ... 1001=5.126V ... 1111=5.51V
3	Reserved	0	
2:0	BOOST_LIM[2:0]	011	<b>Boost Mode Current Limit:</b> 000=0.5A 001=0.75A 010=1.2A 011=1.4A 100=1.65A 101=1.875A 110=2.15A 111=2.45A

Silergy Corp Confidential Prepared for HONESTAR

**REG0B(Read only)**

BIT	Name	POR	DESCRIPTION
7:5	BUS_STAT[2:0]	NA	<b>BUS Status register:</b> 000:No input 001:USB Host SDP 010:USB CDP 011:USB DCP 100:HVDCP 101:Unknown Adapter 110:Non-Standard Adapter 111:OTG
4:3	CHRG_STAT[1:0]	NA	<b>Charging status:</b> 00-Not Charging 01-Pre-charge ( $<V_{BATLOWV}$ ) 10-Fast Charging 11-Charge Termination Done
2	PG_STAT	NA	<b>Power Good Status:</b> 0-Not Power Good 1-Power Good
1	SDP_STAT	NA	<b>USB Input Status:</b> 0-USB100 input is detected 1-USB500 input is detected This bit always read 1 when BUS_STAT is not “001”.
0	VSYS_STAT	NA	<b>VSYS Regulation Status:</b> 0-Not in VSYSMIN regulation ( $BAT > VSYSMIN$ ) 1-In VSYSMIN regulation ( $BAT < VSYSMIN$ )

**REG0C (Read only)**

BIT	Name	POR	DESCRIPTION
7	WATCHDOG_FAULT	NA	<b>Watchdog Fault status:</b> 0-Normal 1-Watchdog timer expiration
6	BOOST_FAULT	NA	<b>Boost Mode Fault Status:</b> 0-Normal 1-BUS overloaded in OTG, or BUS OVP, or battery is too low
5:4	CHRG_FAULT[1:0]	NA	<b>Charge Mode Fault Status:</b> 00-Normal 01-Input fault (BUS OVP or $V_{BAT} < BUS < 3.8V$ ) 10-Thermal shutdown 11-Charge Safety Timer Expiration
3	BAT_FAULT	NA	<b>Battery Fault Status:</b> 0-Normal 1-BATOVP



2:0	NTC_FAULT[2:0]	NA	<b>NTC Fault Status:</b> Buck Mode 000-Normal 010-NTC Warm 011-NTC Cool 101-NTC Cold 110-NTC Hot Boost Mode 000-NTC Normal 101-NTC Cold 110-NTC Hot
-----	----------------	----	---

**REG0D**

BIT	Name	POR	DESCRIPTION
7	VINDPM_MODE	0	<b>VINDPM Threshold Setting Method:</b> 0-Run Relative VINDPM Threshold 1-Run Absolute VINDPM Threshold
6:0	VINDPM[6:0]	0010010	<b>Absolute VINDPM Threshold:</b> $VINDPM = 2.6V + [VINDPM] * 100mV$ Range: 3.9V(0001101)-15.3V(1111111) 0000000~0001101=3.9V 0001110=4.0V ... 0010010=4.4V(Default) ... 1111111=15.3V

**REG0E (Read only)**

BIT	Name	POR	DESCRIPTION
7	THERM_STAT	NA	<b>Thermal Regulation Status:</b> 0-Normal 1-In Thermal Regulation
6:0	BATV[6:0]	NA	<b>ADC Conversion of Battery Voltage(BATV):</b> $BATV = 2.304V + [BATV] * 20mV$ Range: 2.304V(0000000)-4.844V(1111111) 0000000=2.304V(Default) 0000001=2.324V ... 1111111=4.844V

**REG0F (Read only)**

BIT	Name	POR	DESCRIPTION
7	Reserved	0	0
6:0	SYSV[6:0]	NA	<b>ADC Conversion of System Voltage(SYSV):</b> $SYSV=2.304V+[SYSV]*20mV$ Range: 2.304V(0000000)-4.844V(1111111) 0000000=2.304V(Default) 0000001=2.324V ... 1111111=4.844V

**REG10 (Read only)**

BIT	Name	POR	DESCRIPTION
7	Reserved	0	0
6:0	NTCPCT[6:0]	NA	<b>ADC Conversion of NTC Voltage (NTC) as percentage of REGN:</b> $NTC/REGN=21%+[NTCPCT]*0.465%$ Range:21%(0000000)-80.055%(1111111) 0000000=21%(Default) 0000001=21.465% ... 1111111=80.055%

**REG11 (Read only)**

BIT	Name	POR	DESCRIPTION
7	BUS_GD	NA	<b>BUS GOOD Status:</b> 0-No BUS attached 1-BUS attached
6:0	BUSV [6:0]	NA	<b>ADC Conversion of BUS Voltage(VBUS):</b> $VBUS=2.6V+[BUSV]*100mV$ Range:2.6V(0000000)-15.3V(1111111) 0000000=2.6V(Default) 0000001=2.7V ... 1111111=15.3V

**REG12(Read only)**

BIT	Name	POR	DESCRIPTION
7	Reserved	0	
6:0	ICHGR[6:0]	NA	<b>ADC Conversion of Charge current(ICHG) for <math>V_{BAT}&gt;V_{BATSHORT}</math>:</b> $ICHG=[ICHGR]*50mA$ Range:0mA(0000000)-6350mA(1111111) 0000000=0mA(Default)

			0000001=50mA ... 1111111=6350mA Note: For $V_{BAT} < V_{BATSHORT}$ , this register returns 0000000.
--	--	--	--

**REG13(Read only)**

BIT	Name	POR	DESCRIPTION
7	VDPM_STAT	NA	<b>VINDPM Status:</b> 0-Not in VINDPM 1-In VINDPM
6	IDPM_STAT	NA	<b>IINDPM Status:</b> 0-Not in IINDPM 1-In IINDPM
5:0	IDPM_LIM[5:0] ]	NA	<b>Current Input Current Limit setting:</b> IDPM_LIM=100mA+[IDPM_LIM]*50mA Range:100mA(000000)-3.25A(111111) 000000=100mA(Default) 000001=150mA ... 111111=3250mA

**REG14**

BIT	Name	POR	DESCRIPTION
7	REG_RST	0	<b>Register Reset:</b> 0-Keep current register setting(Default) 1-Reset to default register value and reset safety timer Reset to 0 after register reset is completed
6	AICL_OPTIMIZED	NA	<b>Adaptive Input Current Limit Status:</b> 0-Detection in process 1-Maximum input current detected
5:3	PN[2:0]	NA	<b>Device Configuration:</b> 001
2	NTC_PROFILE	NA	<b>Temperature profile:</b> 0-Cold/Hot window 1-JEITA
1:0	DEV_REV[1:0]	NA	<b>Device Revision:</b> Start from 00

## Operation Principle

SY6970 is a fully-integrated switching battery charger with system power path management devices for single cell Li-ion and Li-polymer battery in a wide range of tablet and other portable devices. It integrates the input reverse-blocking FET (RBFET, Q1), high-side switching FET (HSFET, Q2), low-side switching FET (LSFET, Q3), and BATFET (Q4) between system and battery. The extremely low  $R_{DS(on)}$  achieves very high conversion efficiency up to 5.056A charging current. The device also integrates the bootstrap diode for the high-side gate drive.

### Power-On-Reset (POR)

The internal bias circuits are powered from the higher voltage between BUS and BAT. When BUS or VBAT rises above UVLOZ, the sleep comparator, battery depletion comparator and BATFET driver will be active. I<sup>2</sup>C interface is ready for communication. The host can access all the registers after POR.

### Power Up from Battery without DC Source

If only battery is present and the voltage is above depletion threshold ( $V_{BAT\_DPLZ}$ ), the BATFET will turn on and provide power to system. The device in HIZ mode and the REGN LDO stays off to minimize the quiescent current. The low  $R_{DS(on)}$  in BATFET and the low quiescent current on BAT minimize the conduction loss and maximize the battery run time. The device always monitors the discharge current through BATFET. When the system is overloaded or shorted, the device will immediately turn off BATFET and latch off until the input source plugs in again or one of the methods describe in section “BATFET Enable Mode” to re-enable BATFET.

### Power Up from DC Source

When the DC source plugs in, the SY6970 will check the input source voltage to turn on REGN LDO and all the bias circuits. It will also check and set the input current limit before starting the Buck converter when AUTO\_DPDM\_EN bit is set.

#### REGN LDO

The REGN LDO supplies internal bias circuits as well as the HSFET and LSFET gate drive. The LDO also provides bias rail to NTC external resistors. The pull-up rail of STAT can be connected to REGN as well.

When the device is in high impedance mode (HIZ) with REGN LDO off, the device will draw less than  $I_{BUS\_HIZ}$  from BUS during HIZ state. The battery will be powered up when the device is in HIZ mode.

#### Blocking FET (Q1)

After REGN LDO powers up, the SY6970 turns on the blocking FET to reduce the power loss.

#### Input Source Qualification

After REGN LDO powers up, SY6970 will check the current capability of the input source. The input source capability is qualified by the internal active detection circuit.

Once a good input source is present, the status register BUS\_GD bit will go high. An INT is asserted to the host.

### **Input Source Type Detection**

After the REGN LDO is powered, the charger device will run input source type detection when AUTO\_DPDM\_EN bit is set and a DC source plugs in.

The SY6970 can set input current limit through DP/DM PINS. The SY6970 follows the USB battery charging specification 1.2 (BC1.2) and to detect input source (SDP/CDP/DCP) and non-standard (Apple/Samsung) adapter through USB DP/DM lines.

The host can over-write IINLIM register to change the input current limit if necessary. The charger input current will always be limited by the IINLIM register or ILIM pin at all time regardless of adaptive input current limit (AICL) is enabled or disabled.

When AUTO\_DPDM\_EN is disabled, the input source type detection will be bypassed.

### **Force Input Current Limit Detection**

The host can force the charger device to run input current limit detection by setting FORCE\_DPDM bit. After the detection is complete, FORCE\_DPDM will return to 0 by itself and Input source type detection result will be updated.

### **Input voltage limit setting**

The device supports wide range of input voltage limit (3.9V-14V) source and provides two methods to set input voltage limit (VINDPM) threshold to facilitate autonomous detection.

#### 1. Absolute VINDPM (Register VINDPM\_MODE=1)

By setting VINDPM\_MODE bit to 1, the VINDPM threshold setting algorithm is disabled. Register VINDPM is writable and allows host to set the absolute threshold of VINDPM function.

#### 2. Relative VINDPM based on VINDPM\_OS register (Register VINDPM\_MODE=0)

When VINDPM\_MODE bit is 0 (default), the VINDPM threshold setting algorithm is enabled, the VINDPM register is read only and the charger controls the register by using VINDPM threshold setting algorithm. The algorithm allows a wide range of adapter ( $V_{BUS\_OP}$ ) to be used with flexible VINDPM threshold.

## **Converter Power-Up**

After the input current and voltage are set, the converter will be enabled and the HSFET and LSFET start switching. If battery charging is disabled, BATFET will turn off. Otherwise, BATFET will stay on to charge the battery.

The SY6970 will provide soft-start when ramps up the system rail.

As a battery charger, the SY6970 deploys a 1.5MHz Buck regulator. Internal compensation network allows minimizing the peripheral circuit design.

In order to improve light-load efficiency, the device switches to PFM control at light load.



## Adaptive Input current Limit (AICL)

The SY6970 uses adaptive input current limit (AICL) to identify maximum power point of input source. The algorithm automatically identifies maximum input current limit of power source to avoid source overload.

## Boost Mode Operation from Battery

The SY6970 can supply power from the battery to other portable devices on BUS input port. The SY6970 employs a 500KHZ or 1.5MHz (selectable using BOOST\_FREQ bit) Boost regulator.

During Boost mode, the status register BUS\_STAT is set to 111, the BUS output is 5V by default and the output current limit can reach up to 2.4A, selected via I<sup>2</sup>C (BOOST\_LIM bits).

## Power Path Management

The SY6970 accommodates a wide range of input sources from USB, wall adapter, or car battery. The device provides automatic power path selection to supply the system (SYS) from input source (BUS), battery (BAT), or both.

### Narrow VDC Architecture

The device deploys Narrow VDC architecture (NVDC) with BATFET separating system from battery. The minimum system voltage is set by SYS\_MIN bits. Even with a fully depleted battery the system is regulated above the minimum system voltage (default 3.5V)

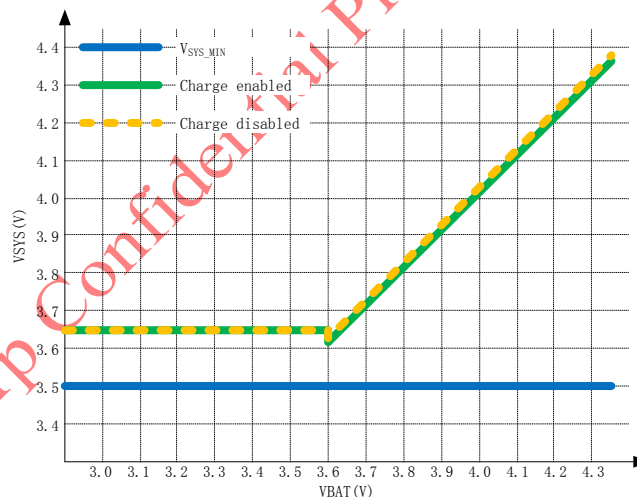

The status register VSYS\_STAT bit will go high when the system is in minimum system voltage regulation.

### Dynamic Power Management

The SY6970 can management the input power limit very well. It has input VINDPM and IINDPM function to protect the input source from over loading.

When input source is over-loaded, either the current will exceed the input current limit (IINDPM) or the voltage will fall below the input voltage limit (VINDPM). The device will reduce the charge current until the input current falls below the input current limit and the input voltage rises above the input voltage limit.

When the charge current is reduced to zero but the input source is still overloaded, the system voltage will start to drop. Once the system voltage falls below the battery voltage, the device will automatically enter the supplement mode where the BATFET turns on and battery starts discharging so that the system is supported from both the input source and battery.

During DPM mode, the status register VDPM\_STAT or IDPM\_STAT will go high.

## Battery Charging Management

The SY6970 charges 1-cell Li-Ion battery with up to 5.0A charge current for high capacity tablet battery. The 10mohm BATFET improves charging efficiency and minimizes the voltage drop during discharging.

### Autonomous Charging Cycle

With battery charging enabled at POR (CHG\_CONFIG bit =1 and /CE pin is low), SY6970 can complete a charging cycle without host involvement. The device default charging parameters are listed below.

Default Charging Setting	
VREG, Charge Voltage	4.208 V
ICHG, Charge Current	2.048 A
IPRECHG, Pre-charge Current	128 mA
ITERM, Termination Current	256 mA
CHG_TIMER, Fast Charge Timer	12 hours

The charger device automatically terminates the charging cycle when the charging current is below termination threshold and charge voltage is above recharge threshold. When a full battery voltage is discharged below recharge threshold (REG04[0]), the SY6970 will automatically start another charging cycle.

The STAT output indicates the charging status of charging (LOW), charging completion or charge disable (HIGH) or charging fault (Blinking). The STAT output can be disabled by setting STAT\_DIS bit. The status register CHRГ\_STAT indicates different charging phases: 00-charging disable, 01-precharge, 10-fast charge (constant current) and constant voltage mode, 11-charging done. Once a charging cycle is complete, an INT will be asserted to notify the host.

The host can always control the charging operation and optimize the charging parameters by writing to the registers through I<sup>2</sup>C.

### Battery Charging Profile

The device charges the battery in three phases: preconditioning, constant current and constant voltage. At the beginning of a charging cycle, the device checks the battery voltage and applies current.

If the charger device is in DPM regulation or thermal regulation during charging, the actual charging current will be less than the programmed value. In this case, termination is temporarily disabled and the charging safety timer is counted at half the clock rate.

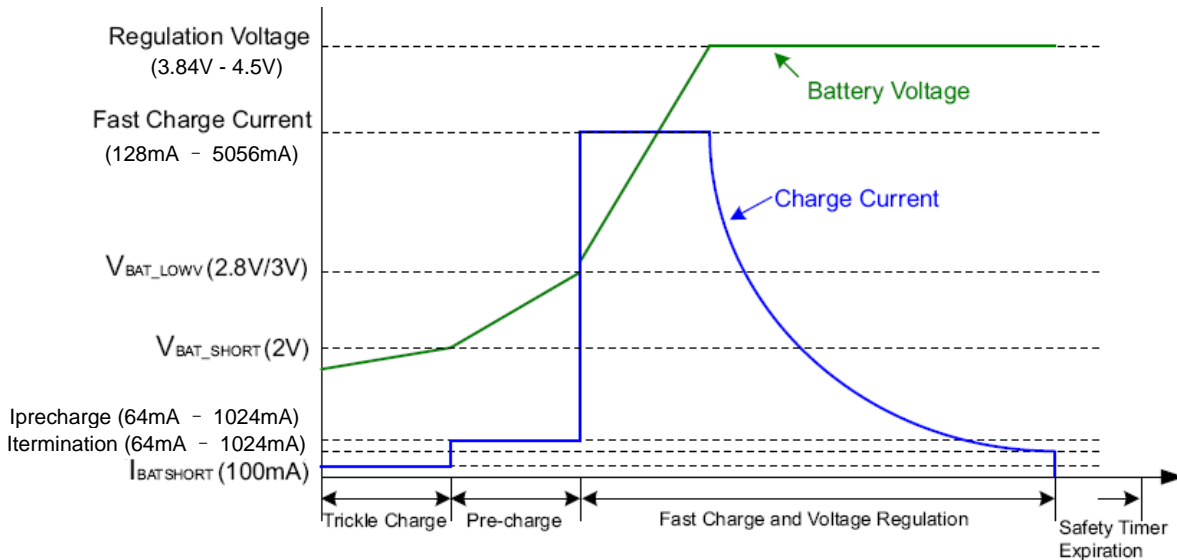

### **Charging Termination**

When termination occurs, the CHRG\_STAT is 11, and an INT is asserted to the host. Termination can be disabled by writing 0 to EN\_TREM.

### **Charging Safety Timer**

The SY6970 has safety timer to prevent extended charging cycle due to abnormal battery conditions.

The device keeps charging the battery until the fast charging safety timer expired. The duration of safety timer can be set by the CHG\_TIMER bits (default = 12 hours). Once the safety timer is expired, the fault register CHRG\_FAULT bits will be set to 11 and an INT will be asserted to the host. The safety timer feature can be disabled by setting EN\_TIMER bit.

During input voltage/current regulation or thermal regulation, the safety timer counts at half clock rate. For example, if the charger is in input current regulation (IINDPM) throughout the whole charging cycle, and the safety time is set to 5 hours, the safety timer will expire in 10 hours. This feature can be disabled by writing 0 to REG09[6].

### **Host Mode and Default Mode**

The SY6970 can operate with or without host. In default mode, the SY6970 can be used as an autonomous charger with no host or with host in sleep.

When the charger is in default mode, WATCHDOG\_FAULT bit is high. When the charger is in host mode, WATCHDOG\_FAULT is low.

After power-on-reset, the device starts in default mode. The registers are in the default settings.

Any host writing command to I<sup>2</sup>C transitions the device from default mode to host mode. To keep the device in host mode, the host has to reset the watchdog timer by writing 1 to WD\_RST bit before the watchdog timer expires or disable watchdog timer by setting WATCHDOG bit to 0.

When the watchdog timer is expired, the device gets back to the default mode.

## Battery Monitor

The device includes a battery monitor to provide fully measurements, including battery voltage, system voltage, thermistor voltage, BUS voltage, and charging current. The results are reported in Battery Monitor Register (REG0E-REG12). The battery monitor can be configured for two conversion modes, by setting CONV\_RATE bit: one-shot conversion (default) and continuous conversion.

For one-shot conversion, the CONV\_START bit can be set to start one conversion. During the conversion, the CONV\_START is set until the conversion is done. The conversion is done after Tconv (max 1s). When one-shot conversion is initiated during input source type detection, the CONV\_START bit is set to indicate conversion is postponed until detection done and conversions is done.

For continuous conversion, the CON\_RATE bit can be set to start the conversion every 1 second automatically. During the conversion, the CONV\_START is set to indicate conversion is in process. The battery monitor exits continuous conversion mode when CONV\_RATE is cleared.

## Status Outputs (/PG STAT and INT)

### Power Good Indicator (/PG)

In the SY6970, PG\_STAT bit is set to indicate a good input source.

### Charging Status Indicator (STAT)

The SY6970 indicates charging state on the open drain STAT pin. The STAT pin can drive LED as the application diagram shows.

STAT Pin State	
CHARGING STATE	STAT
Charging in progress (including recharge)	LOW
Charging complete	HIGH
Sleep mode, charge disable	HIGH
Charge suspend or Boost Mode suspend	blinking at 1Hz

## BATFET (Q4) Control

### BATFET Disable Mode (Shipping mode)

To extend battery life and minimize power when system is powered off during system idle, shipping, or storage, the device can turn off BATFET so that the system voltage is zero to minimize the battery leakage current.

When the host set BATFET\_DIS bit, the charger can turn off BATFET.

### BATFET Enable Mode (Exit Shipping mode)

When the BATFET is disabled (in shipping mode) and indicated by setting BATFET\_DIS, Plugging in adapter or a logic high to low transition on /QON pin can enable BATFET to restore system power:

### **BATFET System Reset**

The BATFET functions as a load switch between battery and system when input source is not plugged-in. By changing the state of BATFET from OFF to ON, system connects to SYS can be effectively have a power-on-reset.

## **Protections**

### **Input Current Limit on ILIM**

For safe operation, the SY6970 has an additional hardware pin to limit maximum input current on ILIM pin. The input maximum current is set by a resistor from ILIM pin to ground as:

$$I_{INMAX} = \frac{K_{ILIM}}{R_{ILIM}}$$

The actual input current limit is the lower value between ILIM setting and register setting IINLIM. If ILIM pin is open, the input current is limited to zero. If ILIM pin is short to ground, the input current limit will be set by the register.

The ILIM pin function can be disabled by setting EN\_ILIM bit to 0. When the pin is disabled, both input current limit function and monitoring will not be available.

### **Thermal Regulation and Thermal Shutdown**

#### **BUCK Mode**

The SY6970 monitors the internal junction temperature  $T_J$  to avoid overheat the chip and limits the IC surface temperature. When the internal junction temperature exceeds the preset limit (TREG bits), the device will lower down the charge current. The wide thermal regulation range from 60 °C to 120 °C allows the user to optimize the system thermal performance.

During thermal regulation, the actual charging current is usually below the programmed battery charging current. Therefore, termination is disabled, the safety timer runs at half the clock rate, and the status register THERM\_STAT goes high.

Additionally, the device has thermal shutdown to turn off the converter and BATFET. The fault register CHRГ\_FAULT is 10 and an INT is asserted to the host. The BATFET and converter are enabled to recover when the IC temperature is below  $T_{TSD\_HYS}$ .

#### **BOOST Mode**

The device monitors the internal junction temperature to provide thermal shutdown during boost mode. When the IC junction temperature exceeds  $T_{SHUT}$ , the boost mode will be disabled by setting OTG\_CONFIG low and BATFET will be turned off. When the IC junction temperature is below  $T_{TSD\_HYS}$ , the BATFET will be enabled automatically to allow system to restore and the host will re-enable OTG\_CONFIG bit to recover.

### **Voltage and Current Monitoring in Buck Mode**

The SY6970 closely monitors the input and system voltage, as well as HSFET and LSFET current for safe buck mode operation.

**Input Over-Voltage (ACOV)**

The maximum input voltage for buck mode operation is  $V_{BUS\_OP}$ . If BUS voltage exceeds  $V_{ACOV}$ , the device will stop switching immediately. During input over voltage (ACOV), the fault register CHRG\_FAULT will be set to 01. An INT is asserted to the host.

**System Over-Voltage Protection (SYSOVP)**

The charger device monitors the voltage at SYS. When system over-voltage is detected, the converter will be stopped to protect components connected to SYS from high voltage damage.

**Voltage and Current Monitoring in Boost Mode**

The SY6970 closely monitors the BUS voltage, as well as HSFET and LSFET current to ensure safe boost mode operation.

**Over Current Protection**

The charge device closely monitors the RBFET(Q1), HSFET(Q2) and LSFET(Q3) current to ensure safe boost operation.

During over-current condition when Boost output current exceeds (BOOST\_LIM), the device will always operate in hiccup mode for protection. Once the over current condition is removed, the boost output will recover. The fault register bit BOOST\_FAULT is set high to indicate fault in boost operation. An INT is also sent to the host.

**Over-Voltage Protection**

Once the BUS voltage exceeds  $V_{OTG\_OVP}$ , the SY6970 stops switching and clears OTG\_CONFIG bit and exits boost mode. The fault register BOOST\_FAULT is set high to indicate fault in boost operation. An INT is sent to the host.

**Battery Protection****Battery Over-Voltage Protection (BATOVVP)**

The battery over-voltage limit is clamped at 4% above the battery regulation voltage. When battery over voltage occurs, the charger device will immediately disable charge. The fault register BAT\_FAULT will go high and an INT will be asserted to the host.

**Battery over Discharge Protection**

When battery voltage is discharged below  $V_{BAT\_DPL}$ , the BATFET will be turned off to protect battery from over discharge. To recover from over-discharge, an input source is required at BUS. When an input source is plugged in, the BATFET will turn on again.

If the battery voltage falls below  $V_{SHORT}$ , the charge current will be reduced to  $I_{BATSHORT}$  or will recharge current for battery safety.

**System Over-Current Protection**

If the system is shorted or  $I_{BAT}$  OCP occurs, the BATFET will be latched off. Section “BATFET Enable Mode” can reset the latch off condition and turn on BATFET.

**Thermistor Temperature Window**

The SY6970 continuously monitors battery temperature by measuring the voltage between the NTC pin and ground, typically determined by a negative temperature coefficient thermistor and an external voltage divider.

**Charging JEITA Guideline Compliance**

JEITA recommends suspending the battery charging process when NTC pin voltage is out of the  $V_{T1}$  to  $V_{T5}$  range, and recovering charging process once the NTC voltage is within the range. JEITA also recommends that the charge current to be reduced to at least half of the charge current or lower at cool temperature (T1–T2), and the charge voltage to be reduced less than nominal charge voltage at warm temperature (T3–T5).

The SY6970 provides flexibility charge voltage/current settings beyond the JEITA requirement. REG09 bit[4] is used for setting the charge voltage to be same as or 150mV lower than the nominal charge voltage (REG06 bit[7:2]) at warm temperature (T3–T5). REG07 bit[0] is used for setting the current setting to be 20% or 50% of fast charge current (REG07 bit[0]) at cool temperature (T1–T2).

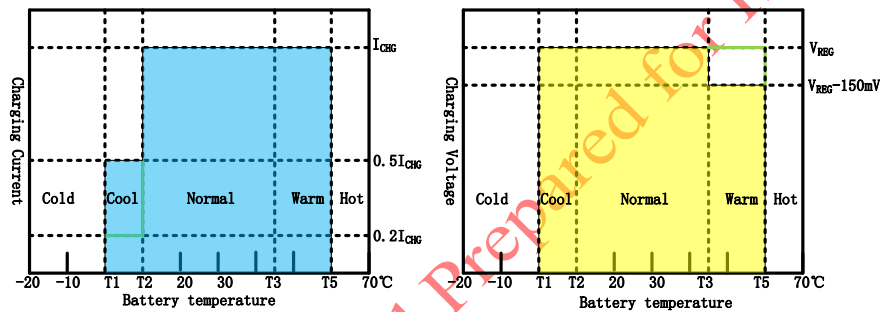

When the NTC fault occurs, the fault register NTC\_FAULT will indicate the actual condition on NTC pin and an INT will be asserted to the host. The STAT pin will indicate the fault when charging is suspended.

**Discharging Cold/Hot Temperature Window**

The device will terminate the battery discharging process when NTC pin voltage is out of the  $V_{BCOLD}$  to  $V_{HOT}$  range. To allow the discharge, the battery temperature must be within this range. The threshold of  $V_{BCOLD}$  and  $V_{HOT}$  is selectable by setting REG01.

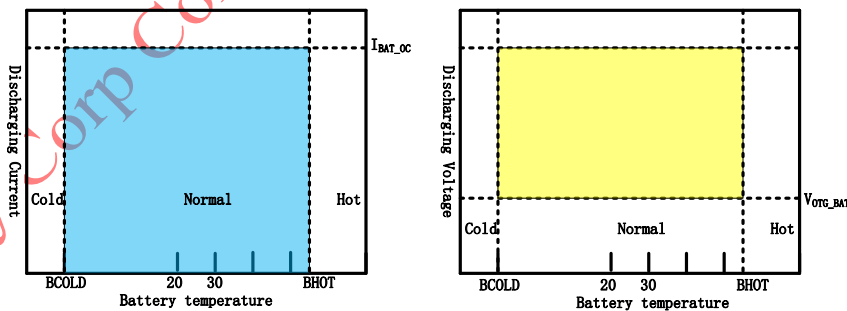

When the NTC fault occurs, the fault register NTC\_FAULT will indicate the actual condition on NTC pin and an INT will be asserted to the host. The STAT pin will indicate the fault when discharging is suspended.



## Serial Interface

The SY6970 uses I<sup>2</sup>C compatible interface for flexible charging parameter programming and instantaneous device status reporting. Only two bus lines are required: a serial data line (SDA) and a serial clock line (SCL). Devices can be considered as masters or slaves when performing data transfers. A master is the device which initiates a data transfer on the bus and generates the clock signals to permit that transfer. At that time, any device addressed is considered a slave.

The device operates as a slave device with address 6AH, receiving control inputs from the master device like micro controller or a digital signal processor. The I<sup>2</sup>C interface supports both standard mode (up to 100kbits), and fast mode (up to 400kbits).

Both SDA and SCL are bi-directional lines, connecting to the positive supply voltage via a current source or pull-up resistor. When the bus is free, both lines will be high. The SDA and SCL pins are open drain.

### Data Validity

The data on the SDA line must be stable during the HIGH period of the clock. The high or low state of the data line can only change when the clock signal on the SCL line is low. One clock pulse is generated for each data bit transferred.

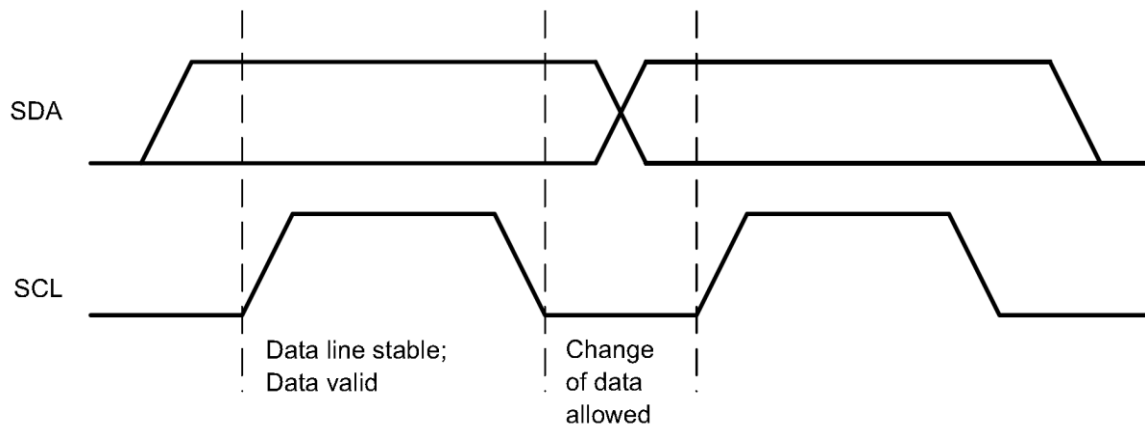

Figure 1. Bit Transfer on the I<sup>2</sup>C Bus

### START and STOP Conditions

All transactions begin with a START (S) and can be terminated by a STOP (P). A high to low transition on the SDA line while SCL is high defines a START condition. A low to high transition on the SDA line when the SCL is high defines a STOP condition.

START and STOP conditions are always generated by the master. The bus is considered busy after the START condition, and free after the STOP condition.



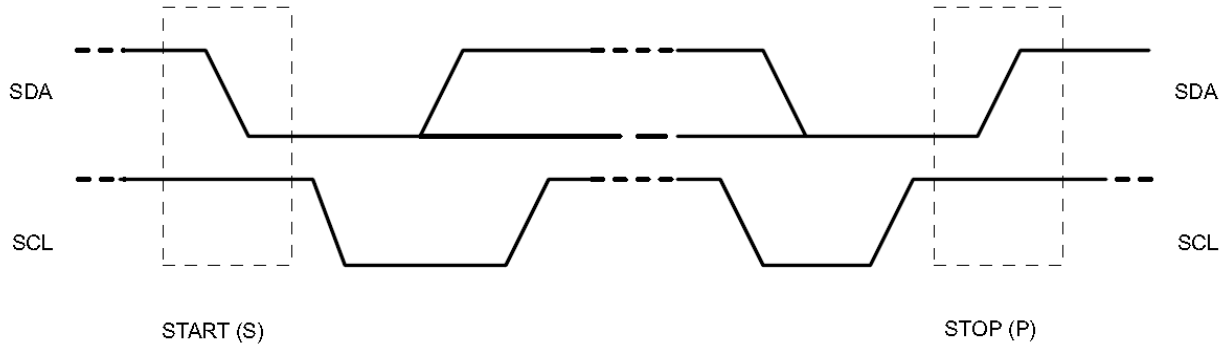

Figure 2. START and STOP conditions

**Byte Format**

Every byte on the SDA line must be 8 bits long. The number of bytes to be transmitted per transfer is unrestricted. Each byte has to be followed by an Acknowledge bit. Data is transferred with the Most Significant Bit (MSB) first. If a slave cannot receive or transmit another complete byte of data until it has performed some other function, it can hold the clock line SCL low to force the master into a wait state (clock stretching). Data transfer then continues when the slave is ready for another byte of data and release the clock line SCL.

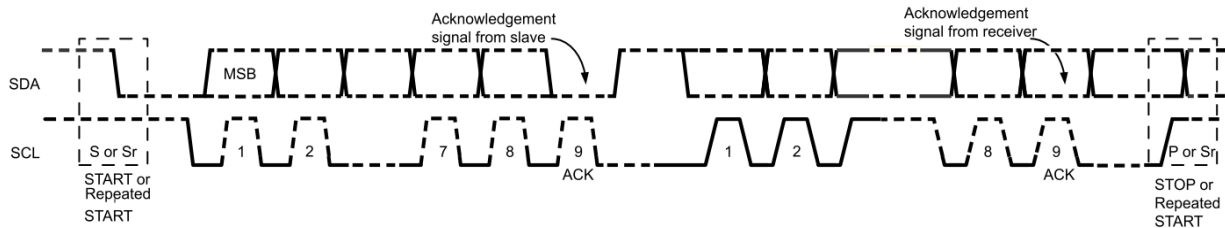

Figure 3. Data Transfer on the I<sup>2</sup>C Bus

**Acknowledge (ACK) and Not Acknowledge (NACK)**

The acknowledge takes place after every byte. The acknowledge bit allows the receiver to signal the transmitter that the byte was successfully received and another byte may be sent. All clock pulses, including the acknowledged 9th clock pulse, are generated by the master.

The transmitter releases the SDA line during the acknowledge clock pulse so the receiver can pull the SDA line LOW and it remains stable LOW during the high period of this clock pulse.

When SDA remains high during the 9th clock pulse, this is the Not Acknowledge signal. The master can then generate either a STOP to abort the transfer or a repeated START to start a new transfer.

**Slave Address and Data Direction Bit**

After the START, a slave address is sent. This address is 7 bits long followed by the eighth bit as a data direction bit (bit R/W). A zero indicates a transmission (WRITE) and a one indicates a request for data (READ).

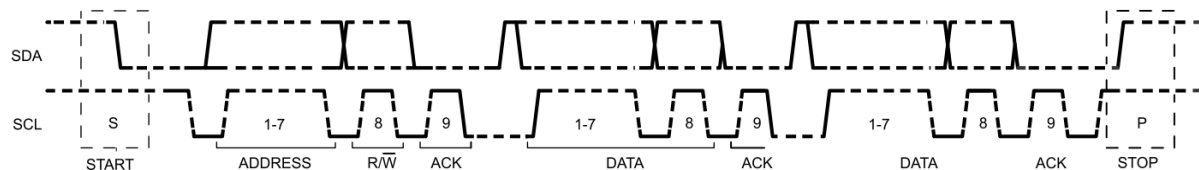

Figure 4. Complete Data Transfer

**Single Read and Write**

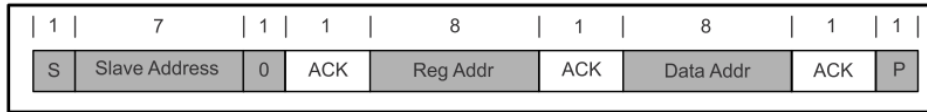

Figure 5. Single Write

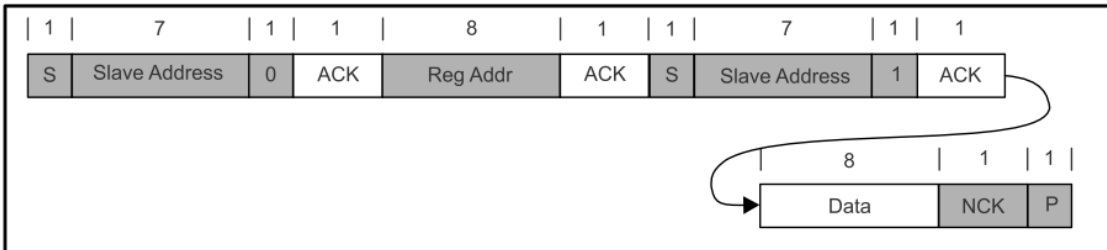

Figure 6. Single Read

If the register address is not defined, the charger IC send back NACK and go back to the idle state.

**Multi-Read and Multi-Write**

The charger device supports multi-read and multi-write on REG00 through REG08.

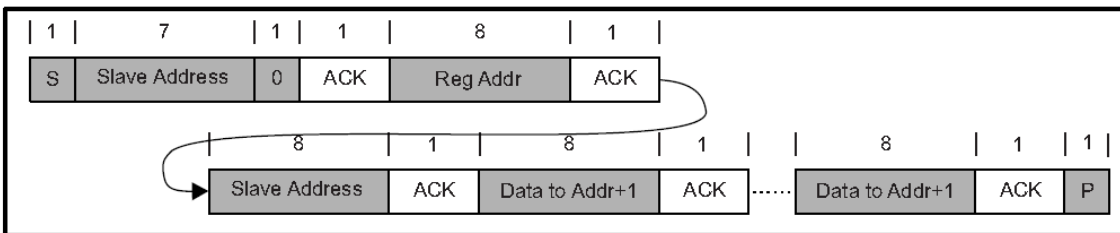

Figure 7. Multi-Write

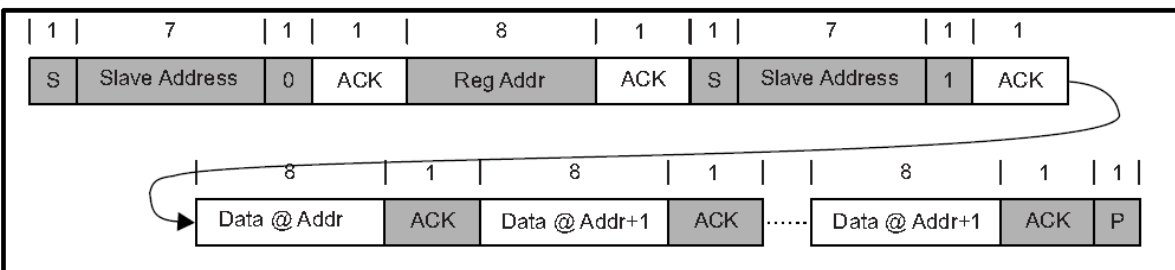

Figure 8. Multi-Read

The fault register REG09 locks the previous fault and only clears it after the register is read. For example, if charge safety timer expiration fault occurs but recovers later, the fault register REG09 will report the fault when it is read the first time, but will return to normal when it is read the second time. To verify real time fault, the fault register REG09 should be read twice to get the real condition. In addition, the fault register REG09 does not support multi-read or multi-write.

**Typical Performance Characteristics**

$T_A=25\text{ }^\circ\text{C}$ ,  $V_{IN}=5\text{V}$ , 1 cell battery, unless otherwise specified.

Adapter Plug-in in Default Mode  
(BAT=3.1V)

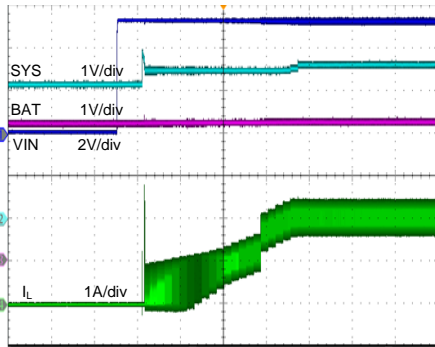

Time (400ms/div)

CV Mode Steady State  
(BAT=4.2V)

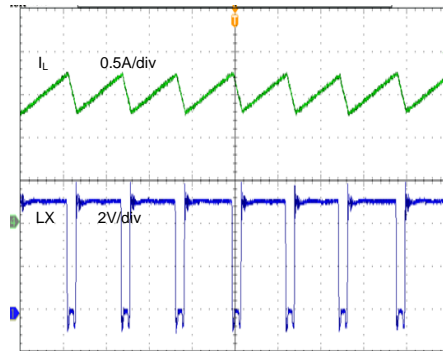

Time (400ns/div)

CV Mode Steady State  
(BAT=3.7V)

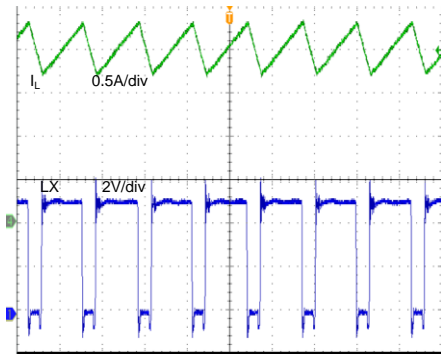

Time (400ns/div)

Charge Enable to Disable

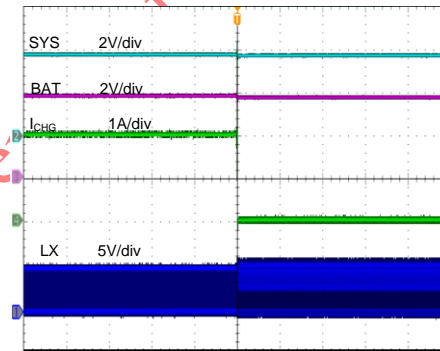

Time (2ms/div)

Boost Mode Steady State  
( $I_{SYS}=1.5\text{A}$ )

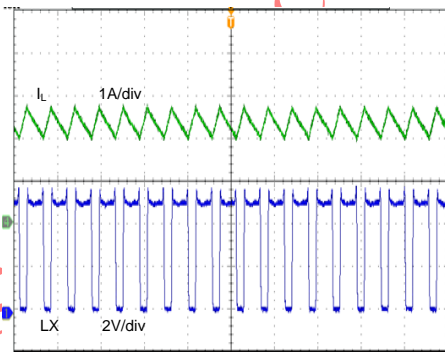

Time (1  $\mu\text{s}$ /div)

## Applications Information

The following battery charger design refers to the “Application Schematic”. This section describes how to select the external components including the inductor, the input and output capacitors.

### Inductor Selection

Higher switching frequency allows the using of the smaller inductor and the capacitor values. The inductor saturation current should be higher than the load current ( $I_{LOAD}$ ) plus half of the ripple current ( $I_{Ripple}$ ):

$$I_{SAT} \geq I_{LOAD} + \frac{1}{2} \times I_{Ripple}$$

The inductor ripple current depends on the input voltage ( $V_{IN}$ ), the duty cycle ( $D = V_{OUT}/V_{IN}$ ), the switching frequency ( $F_{SW}$ ) and the inductance ( $L$ ):

$$I_{Ripple} = \frac{V_{IN} \times D \times (1-D)}{F_{SW} \times L}$$

The maximum inductor ripple current happens with  $D = 0.5$  or close to 0.5. Usually the inductor ripple is designed in the range of (20-40%) maximum charging current as a trade-off between the inductor size and efficiency for a practical design.

### Output Capacitor Selection

The output capacitor in parallel with the battery is used for absorbing the high frequency switching ripple current and smoothing the output voltage. The RMS value of the output ripple current  $I_{RMS}$  is calculated as follow:

$$I_{RMS} = \frac{V_{IN} \times D \times (1-D)}{\sqrt{12L \times F_{SW}}}$$

Where the duty cycle  $D$  is the ratio of the output voltage (battery voltage) over the input voltage for CCM mode which is the typical operation for the battery charger. During the battery charge period, the battery voltage varies from its initial battery voltage to the rated voltage. A typical 10 $\mu$ F ceramic capacitor is a good choice to absorb this current and also has a very small size.

### Input Capacitor Selection

The input capacitor absorbs input ripple current from the Buck converter, which is given by the below equation:

$$I_{RMS} = \frac{V_{LOAD} \times \sqrt{V_{OUT} \times (V_{IN} - V_{OUT})}}{V_{IN}}$$

This RMS ripple current must be smaller than the rated RMS current in the capacitor datasheet. At the same time, the input capacitor is also as the output capacitor when Boost works. At this condition, the input capacitor can be calculated as below:

$$C_{IN} = \frac{I_{BUS} \times (V_{BUS} - V_{BAT})}{F_{SW} \times V_{BUS} \times V_{RIPPLE}}$$

Usually  $V_{RIPPLE}$  is designed less than 0.5% of the Boost output voltage. A typical 10 $\mu$ F ceramic capacitor is a good choice to absorb this current and also has a very small size. For best performance,  $V_{BUS}$  should be decoupled to PGND with 1 $\mu$ F capacitance. The remaining input capacitor should be place on PMID.

### Layout Design:

The layout design of the SY6970 regulator is relatively simple. For the best efficiency and to minimize noise problems, we should place the following components close to the IC:  $C_{PMID}$ ,  $C_{REGN}$  and  $C_{BOOT}$ .

- 1) It is desirable to maximize the PCB copper area adjacent to PGND pin to achieve the best thermal and noise performance. If the board space allows, a ground plane is highly desirable.
- 2)  $C_{PMID}$ ,  $C_{REGN}$  and  $C_{BOOT}$  must be close to the IC.
- 3) The loop area formed by  $C_{PMID}$  and PGND must be minimized. The PCB copper area adjacent to LX pin must be minimized to avoid the potential noise problem. The following picture is the recommended layout design of LX,  $C_{PMID}$  and  $C_{BOOT}$ .

## QFN4x4-24 Package outline & PCB Layout

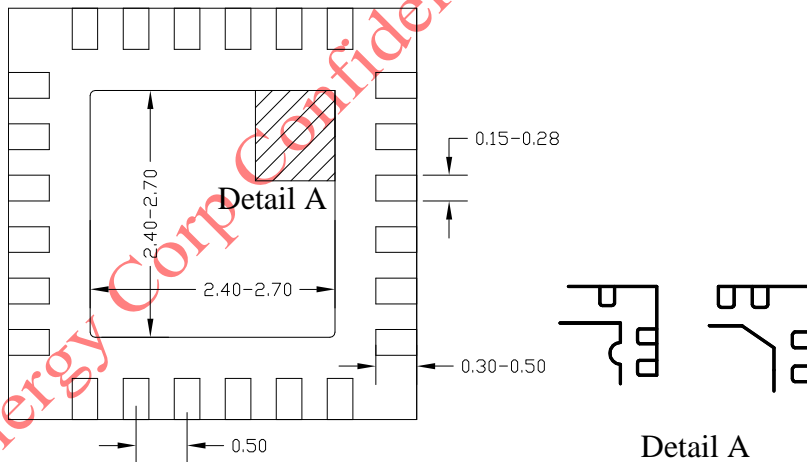
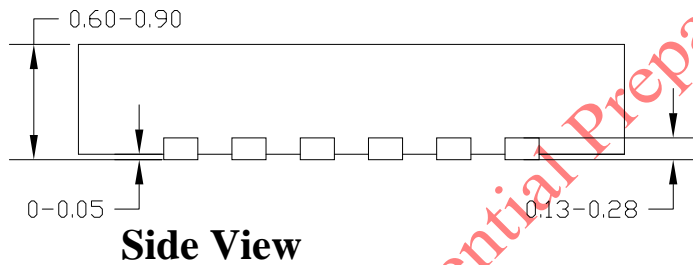
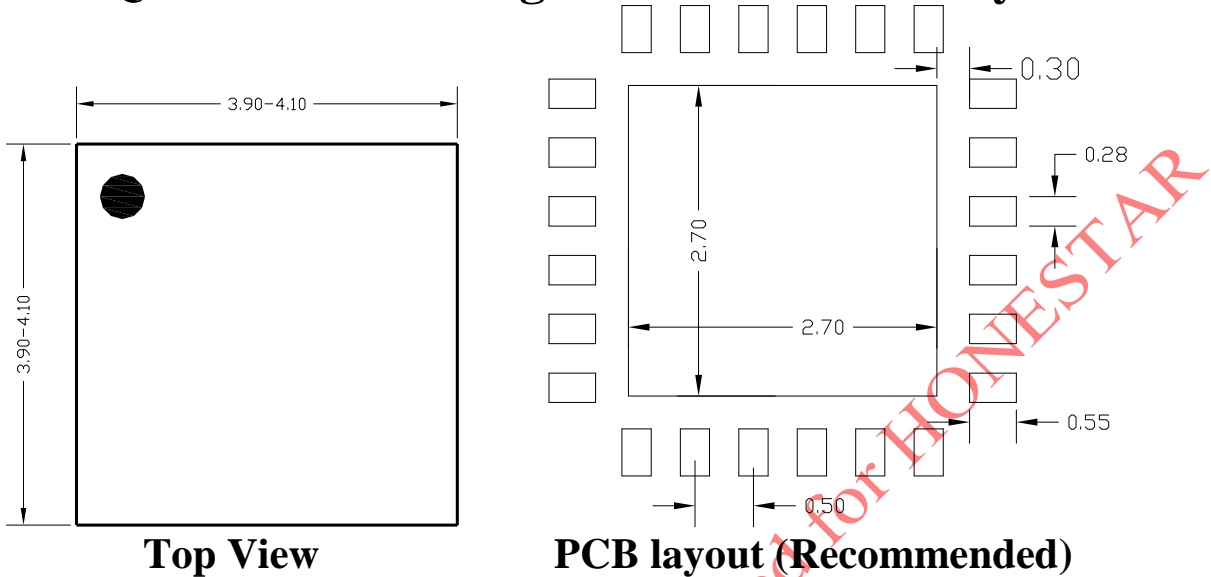

**Notes:** All dimension in MM and exclude mold flash & metal burr